



frascio®



m i n i m a
c o l l e c t i o n

m i n i m a
c o l l e c t i o n

Eleganza, futuro,
leggerezza, compattezza.

*Elegance, future, lightness,
compactness.*

Q30R
system

MINIMA, LA COLLEZIONE DI MANIGLIE
PER ENTRARE NEL FUTURO

Frascio presenta la collezione **minima**, sei maniglie che nascono per entrare nei luoghi del mondo futuro. Questa collezione si contraddistingue per le sue forme decise, le dimensioni ridotte e la nuova rosetta da 30 mm di diametro che consente di integrarsi con il collo della maniglia così da apparire un tutt'uno con la porta.

La collezione **minima** si compone di tre maniglie con rosetta quadra e tre con rosetta tonda per offrire un ventaglio di soluzioni estetiche che possano rispondere agli stili di arredo più vari.

La collezione si distingue per il suo approccio green utilizzando l'alluminio conosciuto per le sue qualità di riciclabilità e leggerezza.

MINIMA, THE COLLECTION OF
HANDLES TO ENTER THE FUTURE

*Frascio presents **minima** collection, six handles that were created to enter the future. This collection is characterized by bold shapes, small size and the new 30mm diameter rose that allows you to integrate with the neck of the handle to appear as one with the door.*

*The **minima** collection consists of three handles with square rose and three with round rose to offer a range of aesthetic solutions that can respond to the most varied styles of furniture. The collection stands out for its green approach using aluminium known for its qualities of recyclability and lightweight.*

IL SISTEMA Q30R

Un sistema evoluto, quello del nuovo standard da 30 mm, che dimostra quanto Frascio sia proiettata ad offrire prodotti e soluzioni rivolte al futuro.

Nella storia di Frascio c'è grande attenzione ai dettagli e agli accessori dedicati alle maniglie: nella gamma troviamo rosette e bocchette di diversa foggia con diametri da 50 mm, da 45 mm con spessori variabili da 10 a 5 mm.

Tutto ciò per offrire un'integrazione ottimale con le esigenze di inserimento negli arredi dai più classici ai più moderni.

Con la collezione **minima** Frascio presenta il nuovo standard di rosetta compatto: il sistema Q30R dove 30 sta per 30 mm di diametro e Q e R stanno per forma quadrata e rotonda. Il nuovo standard consente di avere un'immagine pulita e integrata della maniglia sulla porta.

Alle rosette vengono abbinati sia le bocchette per le chiavi sia il sistema di nottolini WC.

THE Q30R SYSTEM

An advanced system, that of the new 30mm standard, which demonstrates how much Frascio is projected to offer products and solutions for the future.

In the history of Frascio there has been great attention to detail and accessories dedicated to handles, in the range we find roses and escutcheons of different shapes with diameters from 50 mm or 45 mm and with thicknesses ranging from 10 to 5mm.

All this to offer an optimal integration with the needs of insertion in the furnishings from the most classic to the most modern.

*With **minima** collection Frascio presents the new standard of compact rose: the Q30R system where 30 stands for 30mm in diameter and Q and R stand for square and round shapes.*

The new standard allows you to have a clean and integrated image of the handle on the door.

The roses are combined with both escutcheons for keys and bathroom turns.

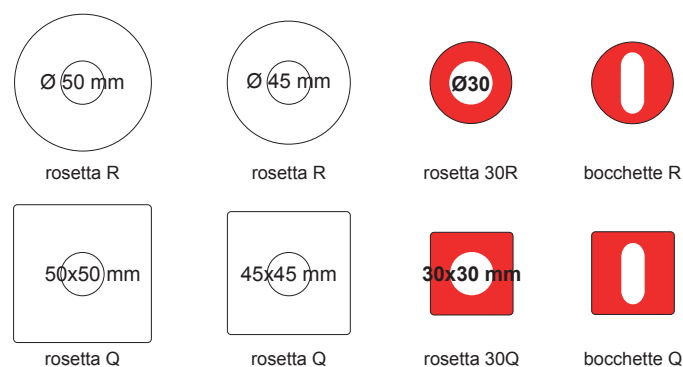

INDEX

QUARTO

p. 06

INDIX

p. 10

SASH

p. 14

TAPE

p. 18

HEMISFERA

p. 22

CUT

p. 26

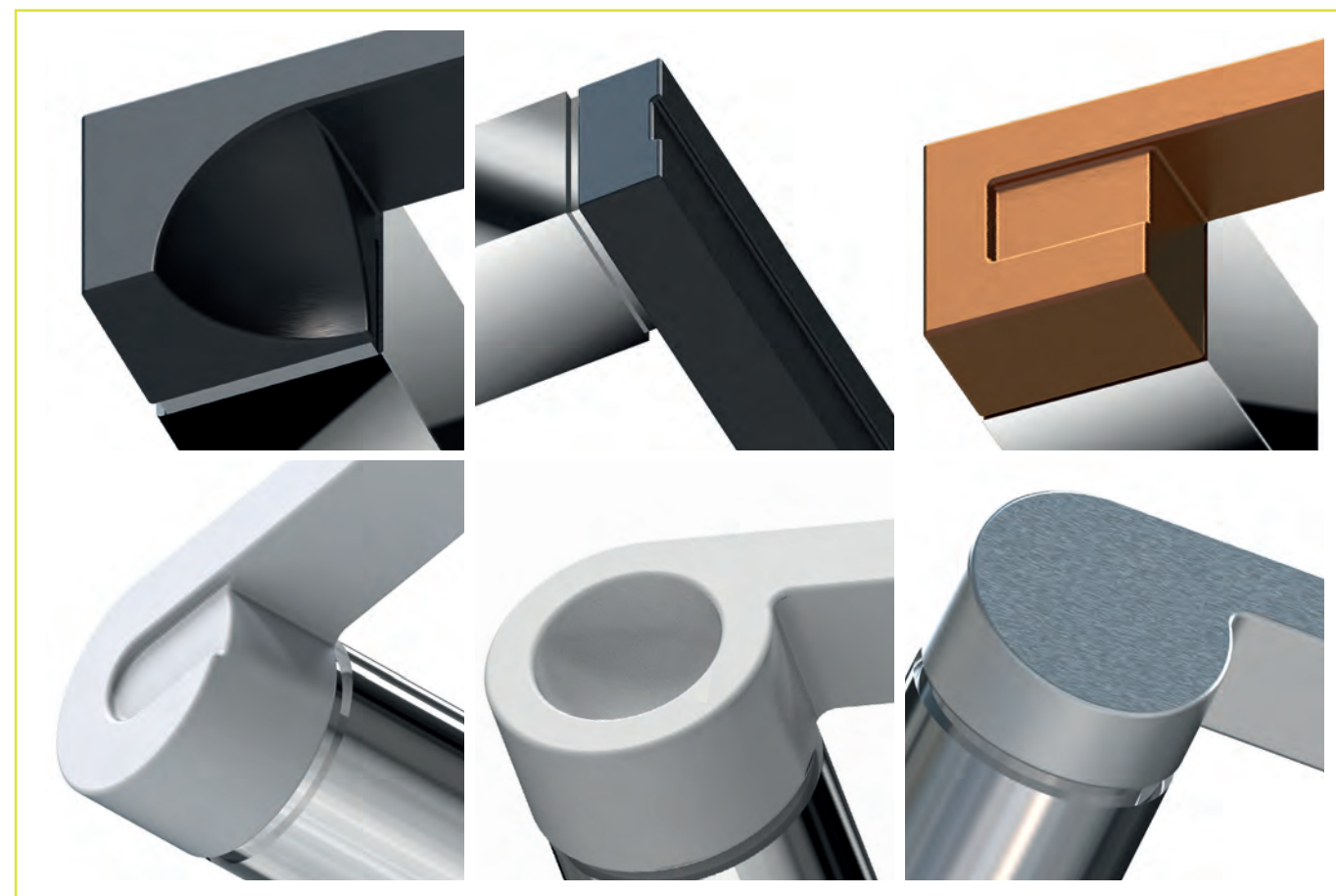

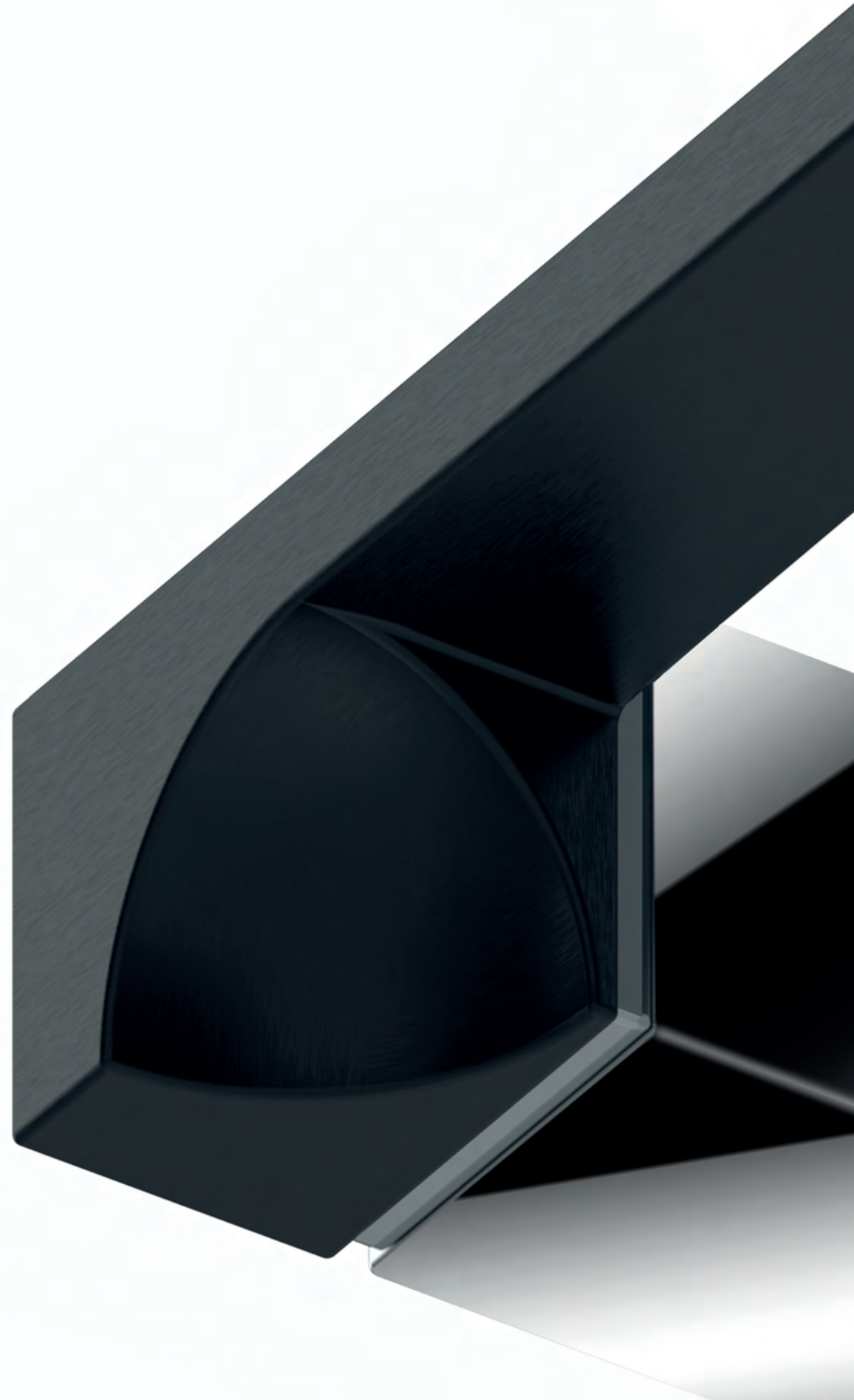

Una maniglia che vede nel suo gambo una figura di un quarto di cupola, ne risulta un insieme di grande carattere pur nella semplicità della linea.

A handle that sees in its stem a figure of a quarter of a dome, the result is a set of great characteristics despite the simplicity of the line.

COLORI DISPONIBILI
AVAILABLE COLORS

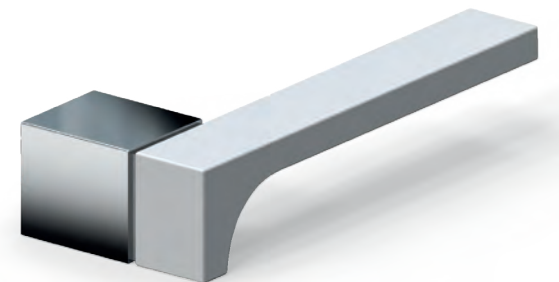
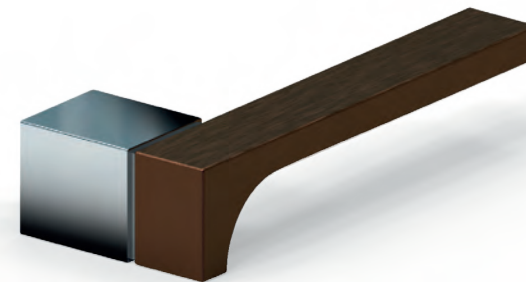
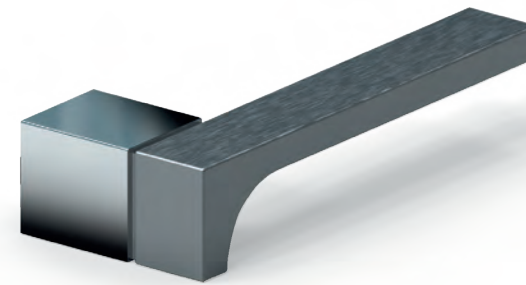

COLORI IN DEFINIZIONE
COLORS IN DEVELOPMENT

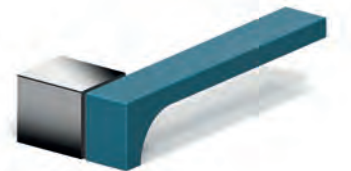
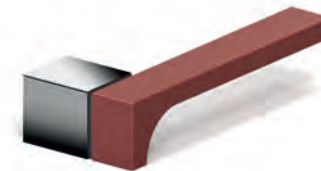

RAL 1035

RAL 2013

RAL 5025

CROMATO SATINATO
CHROME SATIN

BRONZO TREND
BRONZE TREND

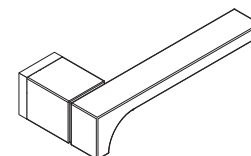
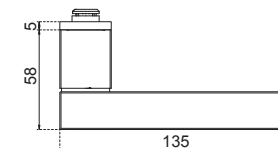
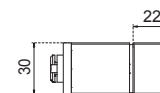
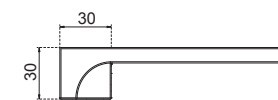

NERO OPACO
MATT BLACK

BIANCO OPACO
MATT WHITE

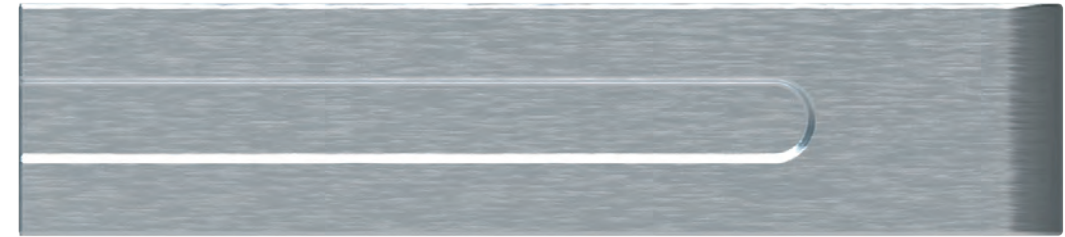
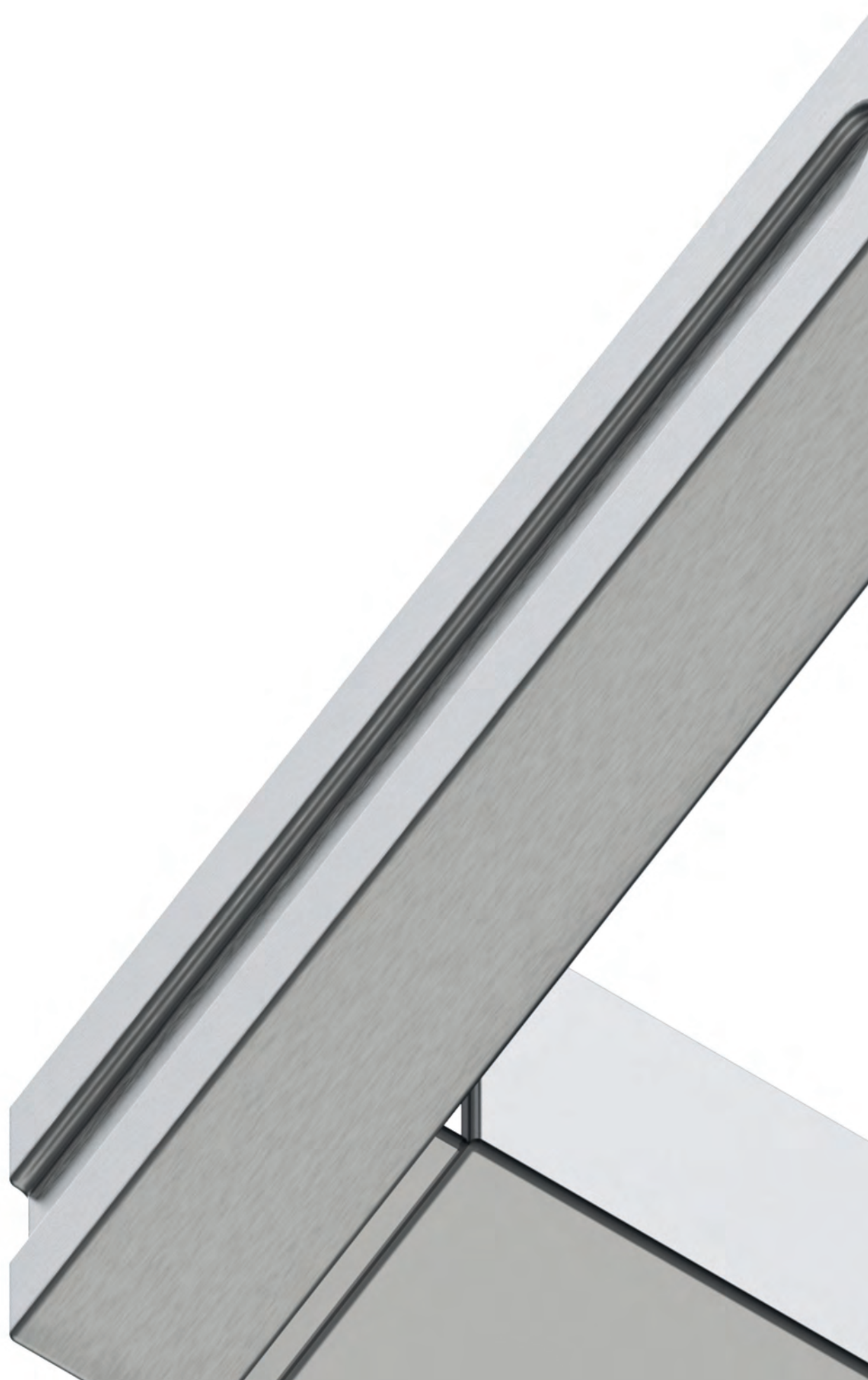

Un volume lineare che trova al suo interno un segno che ne indica la direzione: una firma di eleganza e dinamicità.

A linear form that holds inside a sign that indicates the direction: a sign of elegance and dynamism.

COLORI DISPONIBILI
AVAILABLE COLORS

INDIX

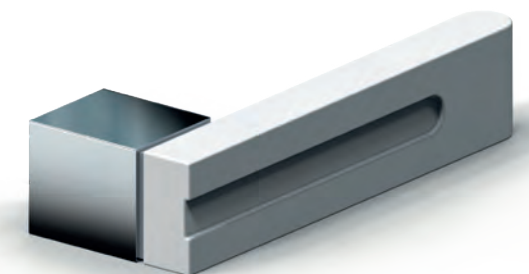
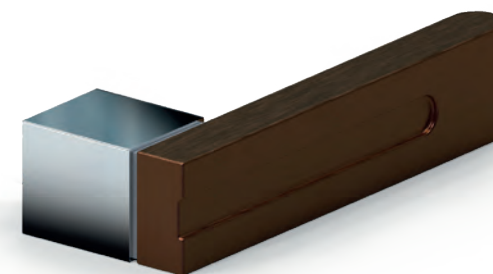
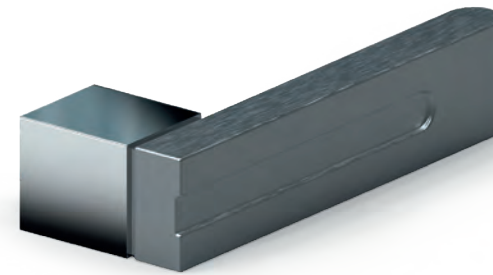

COLORI IN DEFINIZIONE
COLORS IN DEVELOPMENT

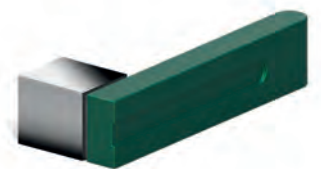
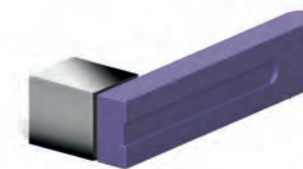

RAL 1035

RAL 4011

RAL 6036

CROMATO SATINATO
CHROME SATIN

BRONZO TREND
BRONZE TREND

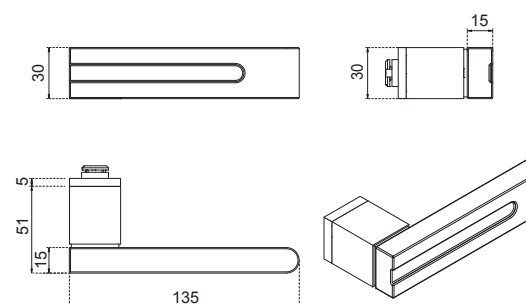

NERO OPACO
MATT BLACK

BIANCO OPACO
MATT WHITE

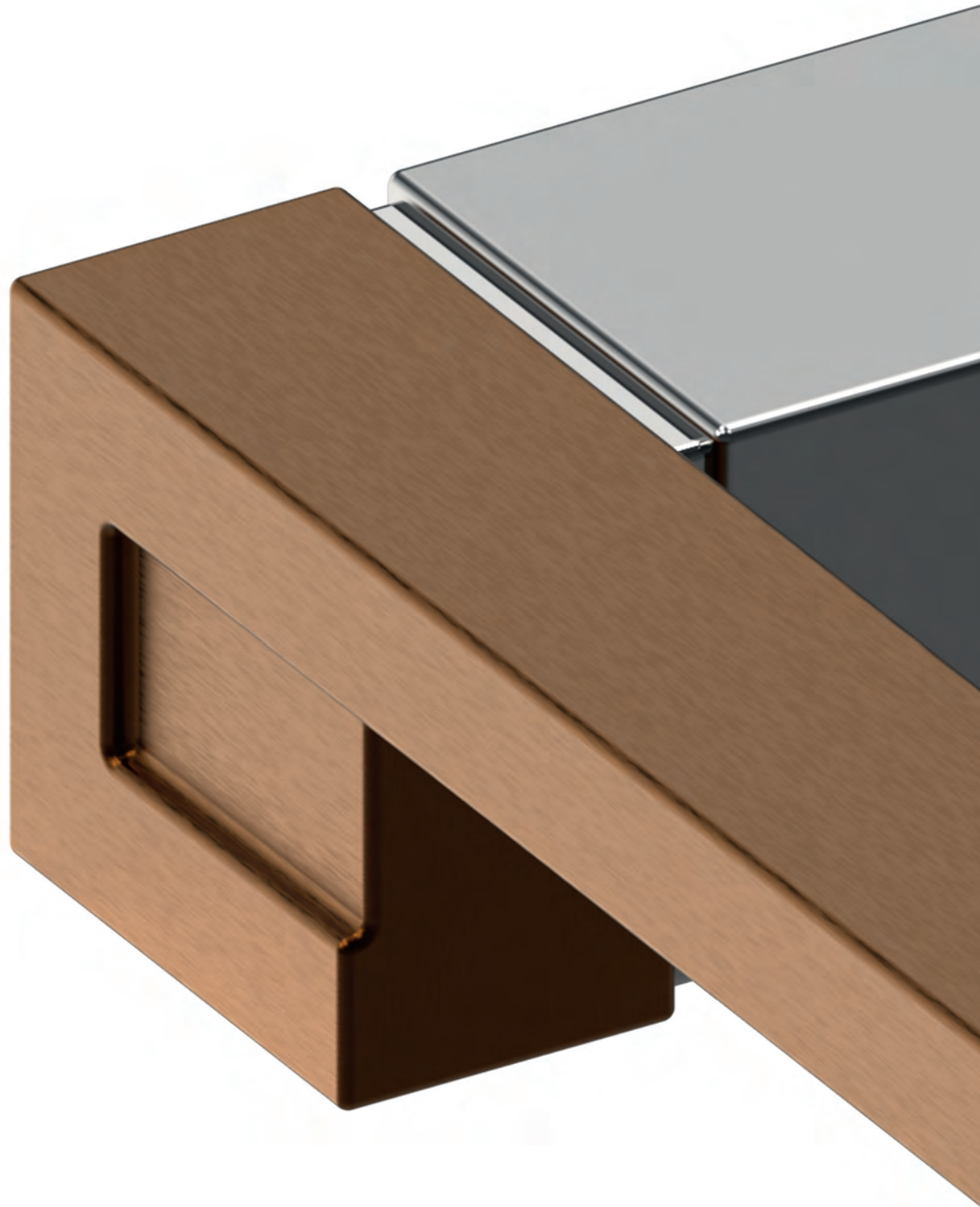

Una maniglia che si caratterizza con una fascia che raccoglie il volume quadrangolare del gambo, valorizzandone il suo profilo.

A handle that is characterized by a sash that collects the quadrangular volume of the stem, enhancing its profile.



Frascio®

COLORI DISPONIBILI
AVAILABLE COLORS

SASH

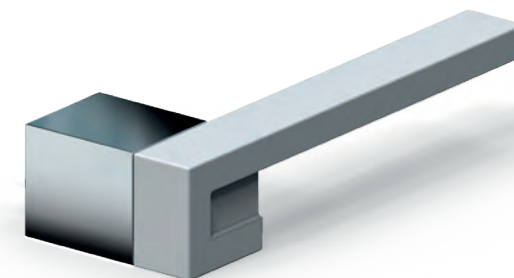

COLORI IN DEFINIZIONE
COLORS IN DEVELOPMENT

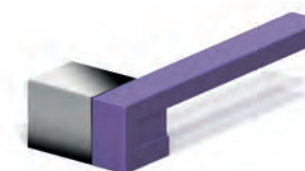
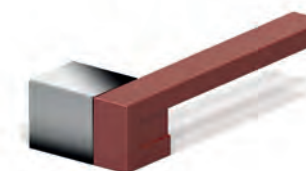

RAL 1035

RAL 2013

RAL 4011

CROMATO SATINATO
CHROME SATIN

BRONZO TREND
BRONZE TREND

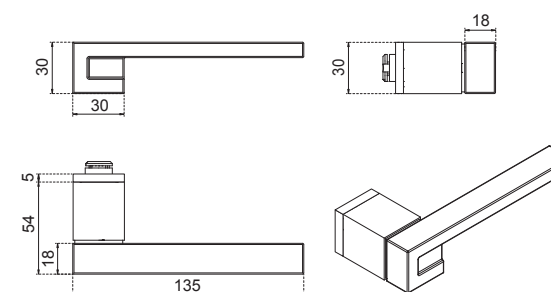

NERO OPACO
MATT BLACK

BIANCO OPACO
MATT WHITE

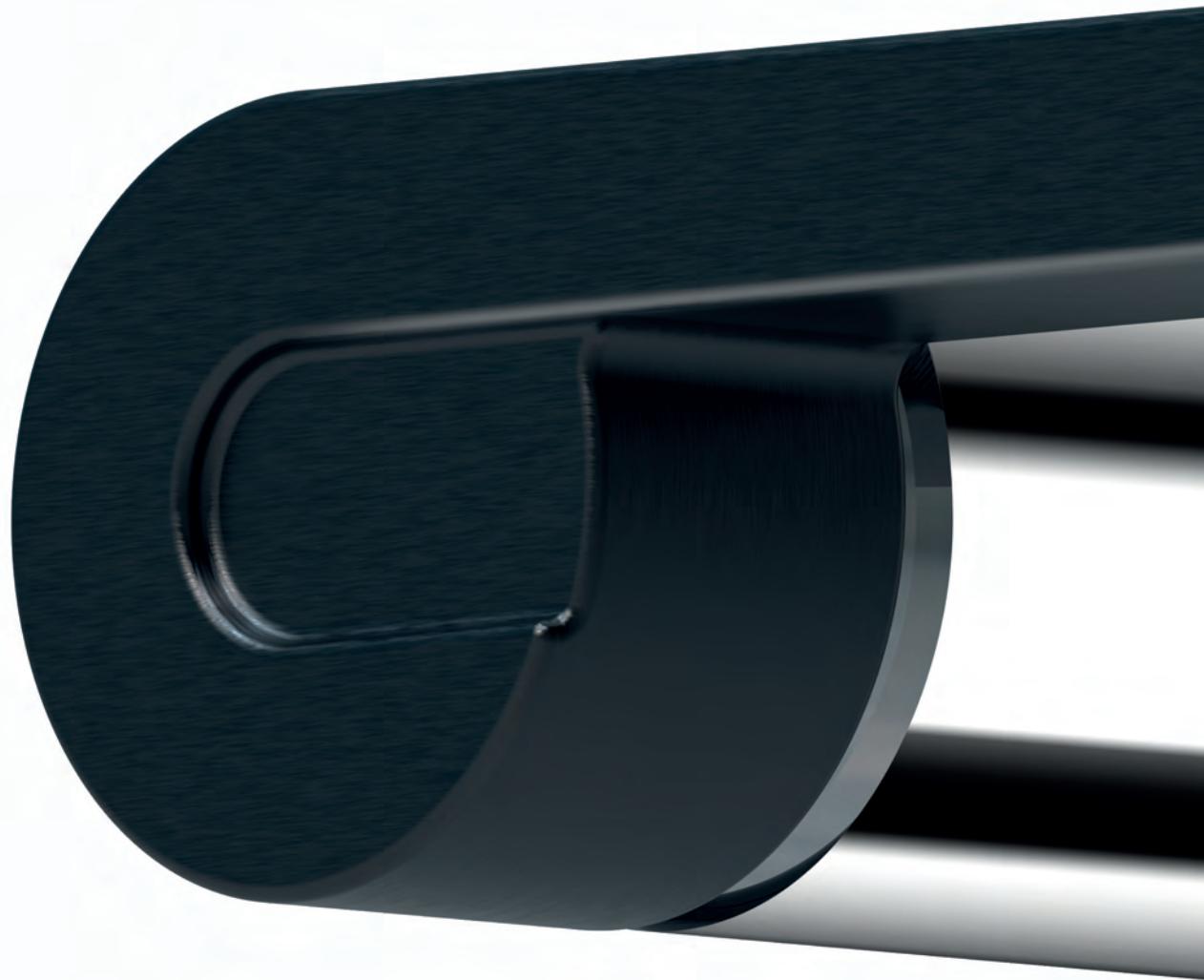

Il nastro si avvolge sul gambo tondo diventando un segno dinamico e al tempo stesso di grande personalità.

The ribbon wraps on the round stem becoming a dynamic sign and at the same time of great personality.



Frascio®

COLORI DISPONIBILI
AVAILABLE COLORS

TAPE

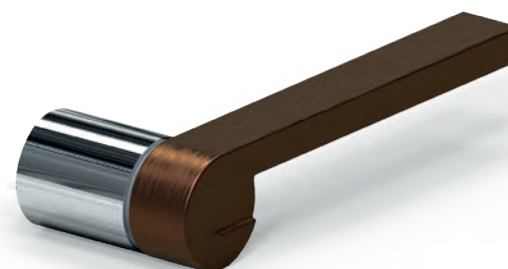

COLORI IN DEFINIZIONE
COLORS IN DEVELOPMENT



RAL 6036

RAL 5025

RAL 4011

CROMATO SATINATO
CHROME SATIN

BRONZO TREND
BRONZE TREND

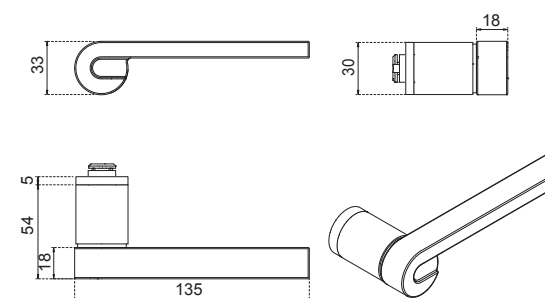

NERO OPACO
MATT BLACK

BIANCO OPACO
MATT WHITE

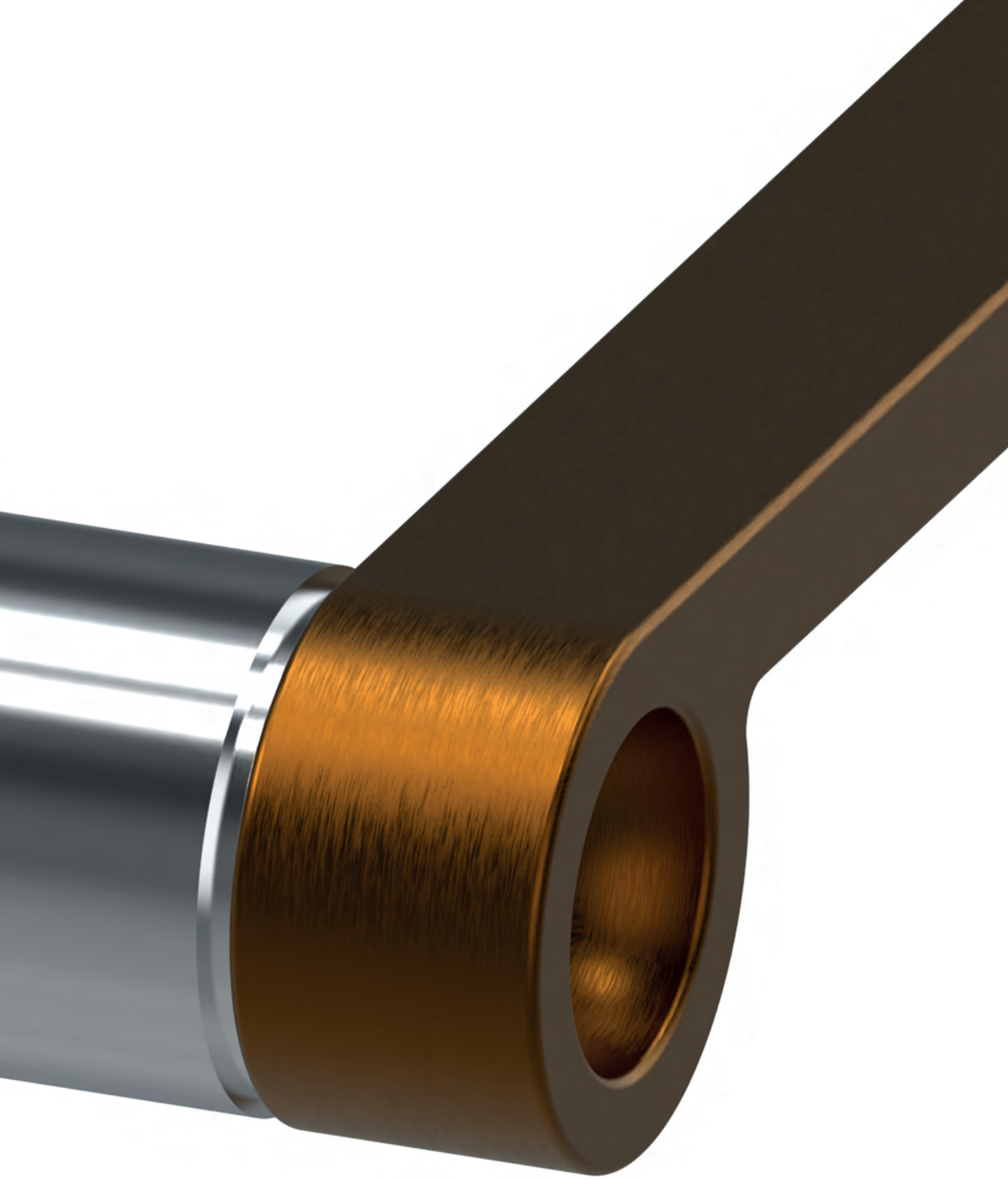

Frascio®

HEMISFERA

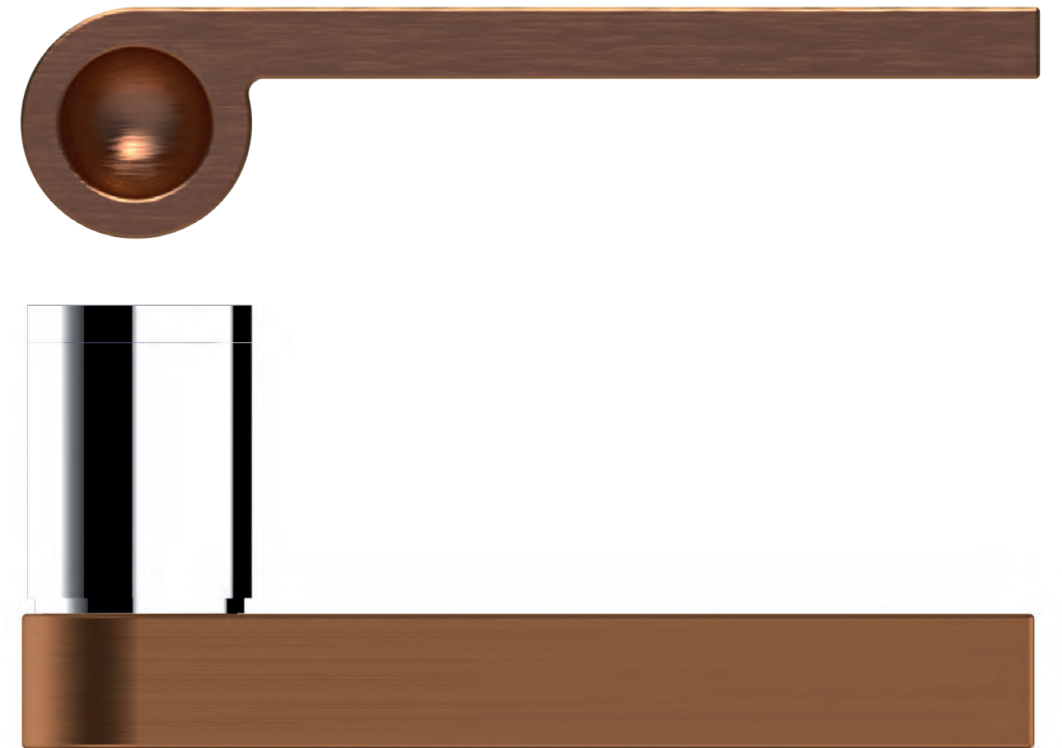

Una semplice semisfera concava al centro del gambo dona a questa maniglia un carattere rigoroso.

A simple concave hemisphere in the middle of the stem gives to this handle a rigorous character.



Frascio®

COLORI DISPONIBILI
AVAILABLE COLORS

HEMISFERA

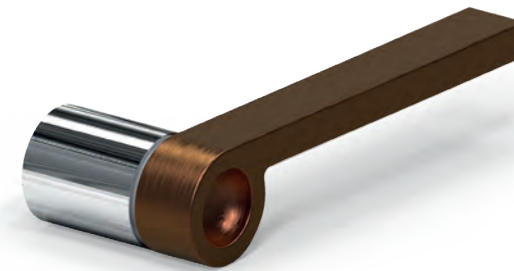

COLORI IN DEFINIZIONE
COLORS IN DEVELOPMENT



RAL 1035



RAL 2013



RAL 6036

CROMATO SATINATO
CHROME SATIN

BRONZO TREND
BRONZE TREND

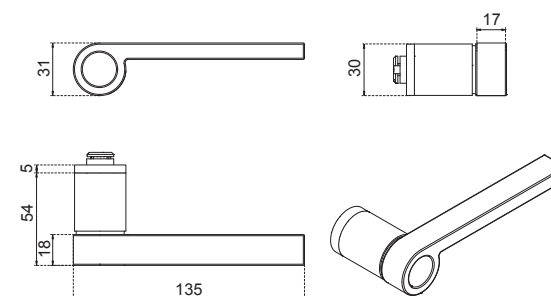

NERO OPACO
MATT BLACK

BIANCO OPACO
MATT WHITE



Un taglio netto del volume, una forma decisa ed efficace nella presa donano dinamicità e forza a questa maniglia.

A clean-cut shape, a strong and effective shape in your grip: gives dynamism and strength to this handle.



Frascio®

COLORI DISPONIBILI
AVAILABLE COLORS

CUT



COLORI IN DEFINIZIONE
COLORS IN DEVELOPMENT



RAL 1035



RAL 2013



RAL 5025

CROMATO SATINATO
CHROME SATIN

BRONZO TREND
BRONZE TREND

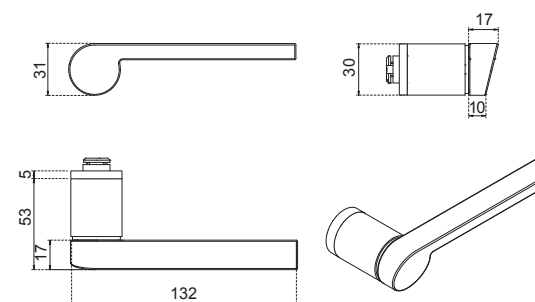

NERO OPACO
MATT BLACK

BIANCO OPACO
MATT WHITE



FRASCIO NEL MONDO

L'azienda è in grado di soddisfare con professionalità le richieste provenienti dal mondo mettendo a disposizione standard tecnici appropriati e soluzioni che rispondono alle effettive esigenze del mercato di riferimento. Le referenze delle opere architettoniche, nelle quali ogni anno vengono inserite le maniglie e i sistemi di apertura Frascio, testimoniano l'affidabilità di una fornitura e di un servizio attento alle necessità più esigenti.

FRASCIO IN THE WORLD

Frascio proudly offers its professional design range to satisfy demands from all over the world, providing technical standards, finishes, and design solutions that meet the needs of the local market. The presence of Frascio's handles in architectural works, that every year grows larger and larger, are proof of a reliability and a service that can comply even with the most demanding requests.

Frascio nasce nel 1945 come laboratorio artigianale.

Cresce costantemente negli anni seguendo un percorso orientato sullo sviluppo e la ricerca nel **settore dei complementi e degli accessori per porte e finestre**, fino a raggiungere il mercato internazionale.

Il continuo **aggiornamento nel campo del design** e l'**interesse verso le ultime innovazioni**, con una particolare attenzione sulle tecniche di lavorazione, l'utilizzo di materiali ecologici e nuove finiture, rende Frascio una realtà sempre in grado di rinnovarsi e di essere vera interprete delle future visioni dell'abitare.

Frascio was founded in 1945 as an artisanal laboratory.

It has steadily grown over the years following a path towards development and research in the **sector of complements and accessories for doors and windows**, reaching the international market. **The constant updates in its designs** and **its interest in the latest innovations**, with particular attention to the manufacturing techniques and to the use of ecological materials and new finishes, makes Frascio a reality always able to renew itself and a true interpreter of future visions of living.

FRASCIO®

FRASCIO S.r.l.

Via Nazionale 6 - 25074 Lavenone (BS) - Italy
Tel. +39 0365 839001 - Fax. +39 0365 83578
e-mail: info@frascio.it - www.frascio.it